

门锁开孔操作步骤:

步骤一:

将开孔模板上的模板①、②、③和操作步骤分开4板块;

步骤二: (锁面板开孔)

- (1) 在门上画一条离地1米(或把手的适当高度)的水平线;
- (2) 模板②与门面贴紧, 对齐门边; 然后将模板中的A-A线与门上所画的1米线对齐;
- (3) 按模板②中的开孔所示, 用笔在门上标识好位置及大小。

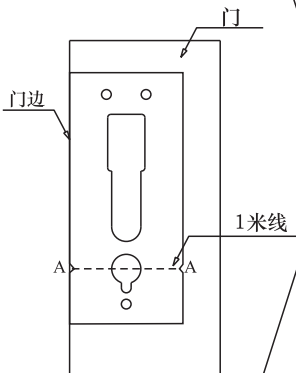

步骤三: (锁体开孔)

- (1) 根据门厚画一条中心线;
- (2) 模板①中的刻度“0”与所画中心线对齐, 再将模板①中的A-A线与在门上所画的1米线对齐;
- (3) 开孔步骤:
 1. 在门标记好中间挖空处的大小及位置, 该区域开孔深度为116mm;
 2. 再对上模板, 通过4个辅助方形孔标出黑色斜纹区域的大小及位置, 该区域开孔深度为5.5mm。

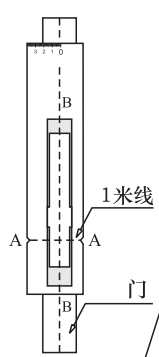

步骤四: (扣板开孔)

- (1) 开好门孔后, 将门关上; 在门框上也标出一条离地的1米线, 再根据门框厚度画出一条中心线;
- (2) 模板③中的C-C线与门框厚度中心线对齐, 再用模板的A-A线与所画1米线对齐;
- (3) 开孔步骤:
 1. 模板对齐后, 先在门标出中间挖空处的大小及位置, 该区域开孔深度为28mm;
 2. 再对上模板, 通过6个辅助方形孔标出黑色斜纹区域的大小及位置, 该区域开孔深度为3mm。

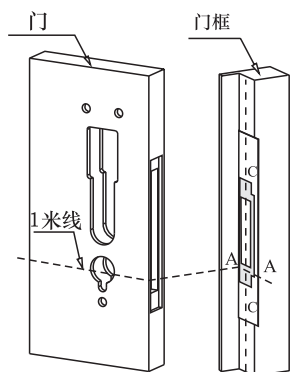

▶ 温馨提示: 1. 确定所标识孔位及大小无误后, 方可开孔; 2. 如果在开门框上的扣板孔时遇到减震条, 需将其厚度减去再去量度门框的厚度。

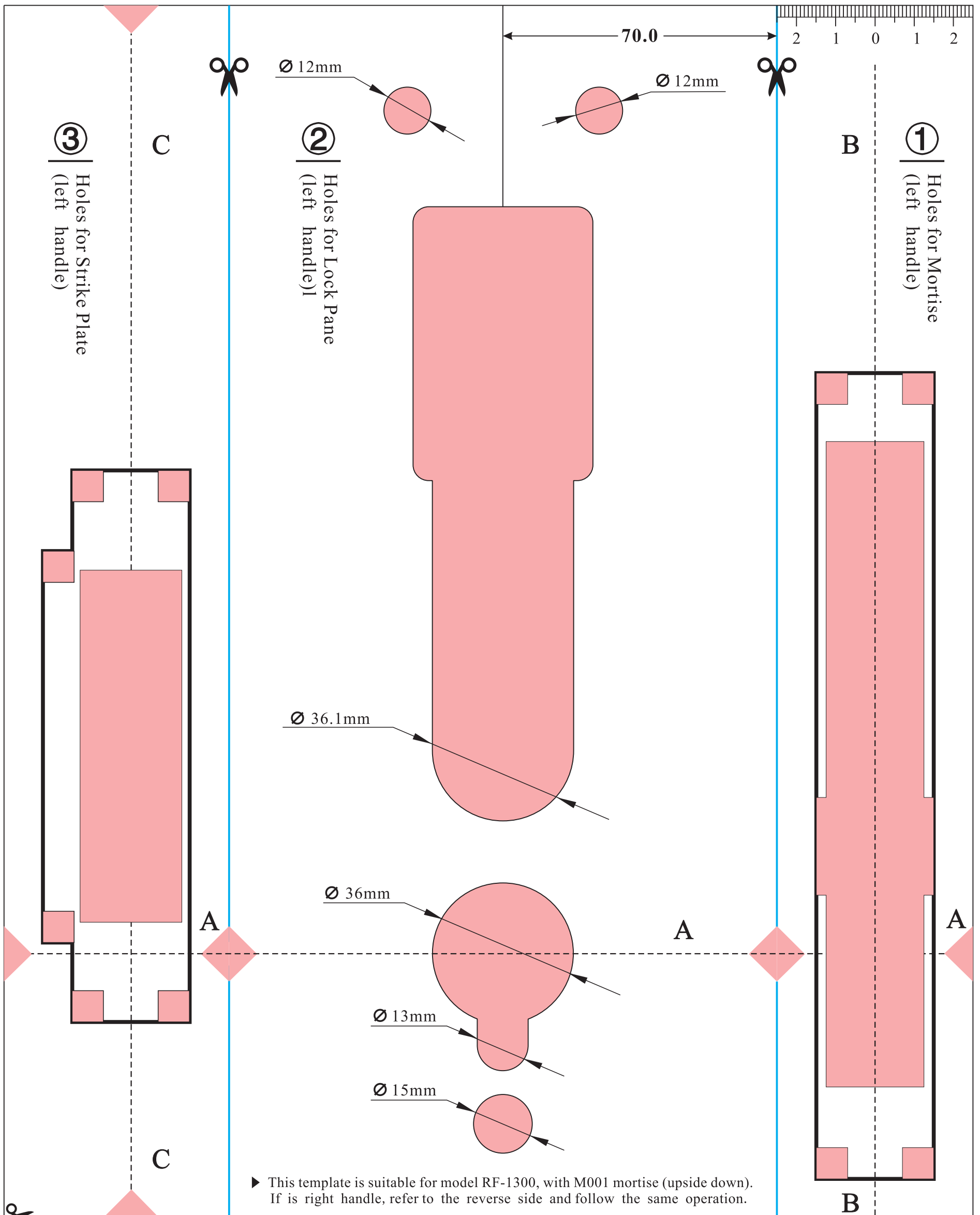

Instruction:

Step 1:
Separate Fig①, ②, ③ & instruction part along the dotted line (total 4pcs);

Step 2:(holes for Lock Panel)

(1) Draw a horizontal line on the door which is 1-m line distanced to the floor. (1-m line is only for reference, the position of this line can be adjusted according to the height of handle installed.);

(2) Put Fig② against the door and align to door border; then align Line A-A to the line (1-m line) drawn in the 1st step;

(3) Draw lines according to Fig②.

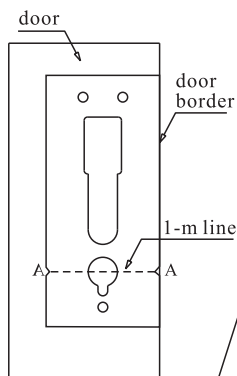

Step 3:(holes for Mortise)

(1) Draw a center line according to door thickness;

(2) Find scale number "0" in Fig①, align the "0" line to the center line drawn in the 1st step, and Line A-A to the 1-m line;

(3) Making holes:

a. Mark the size & position of the middle hole, make its depth as 116mm;

b. Find 4 holes on each edge on template, put the template back to locate the grey area, and make its depth as 5.5 mm.

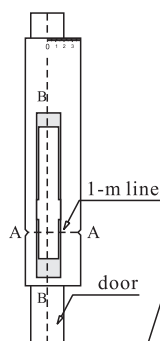

Step 4:(holes for Strike Plate)

(1) After making holes on door, close the door and draw a horizontal 1-m line on door frame, then draw another center line according to thickness of door frame;

(2) Align Line C-C on Fig③ to the center line on door frame, and align Line A-A on Fig③ to 1-m line on door frame;

(3) Making holes:

a. Mark the size & position of the middle hole, make its depth as 28mm;

b. Find 6 holes on each edge on template, put the template back to locate the grey area, and make its depth as 3 mm.

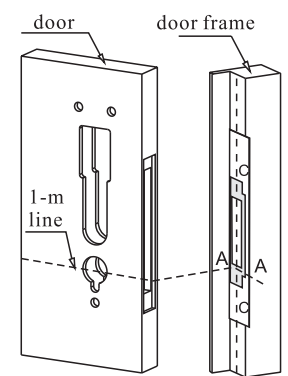

Remarks:

1. Position and size of the holes must be confirmed before cutting. 2. If there is shock absorption bar on door frame, its thickness should be excluded from door thickness.